

**TESSERA**<sup>4</sup>  
OFF ROAD ACCESSORIES  
**4X**

*Think Quality!*



Tessera-4x4

**THE AVANT-GARDE**  
*Ford*  
**"TESSERA ROLL+"**

RANGER

*Time to make  
a statement*

---

**Peerless Refinement  
and Power**  
for your pickup truck





Details matter...



## Capable of great transformation

The only roll top cover in the global market that can be upgraded from basic to “spring” (s-Kit) or “electric” (e-Kit) version by just adding one of our kits





PERFORMANCE  
IN ANY CONDITION

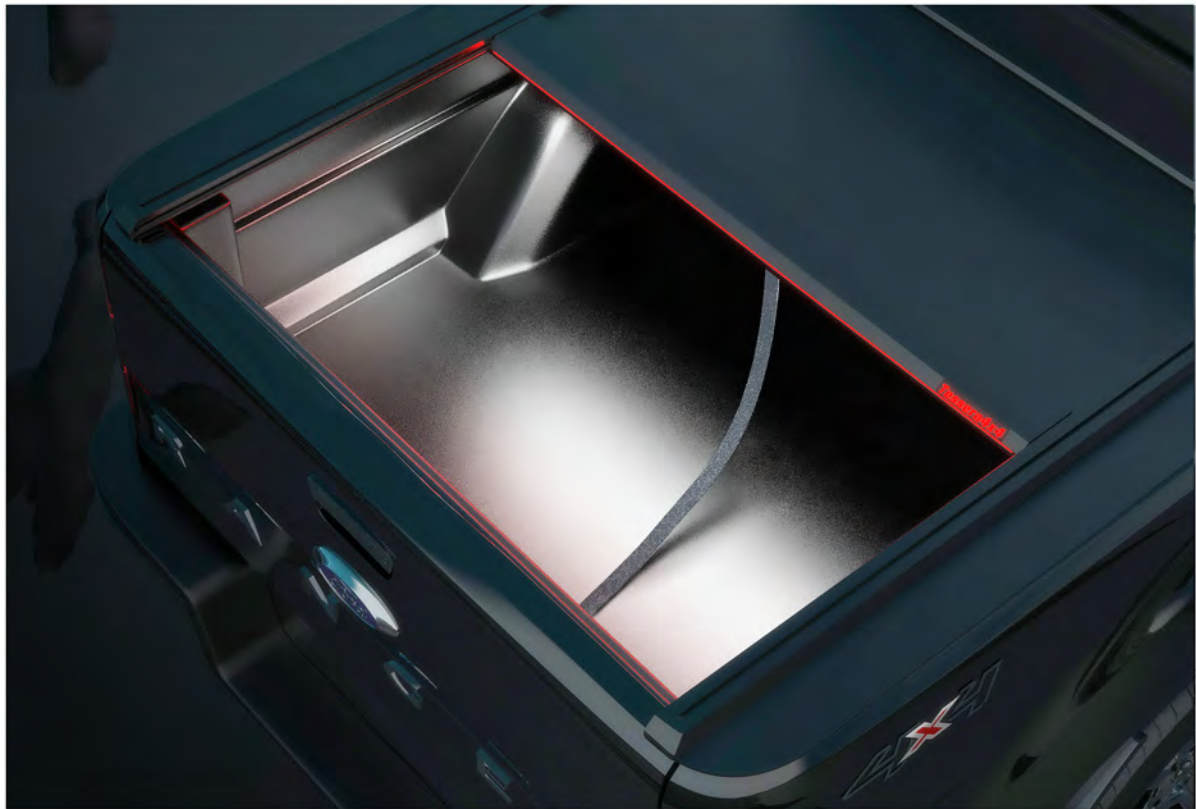



Enhance the appearance and capability  
of your pickup truck with our range of tough  
and versatile accessories





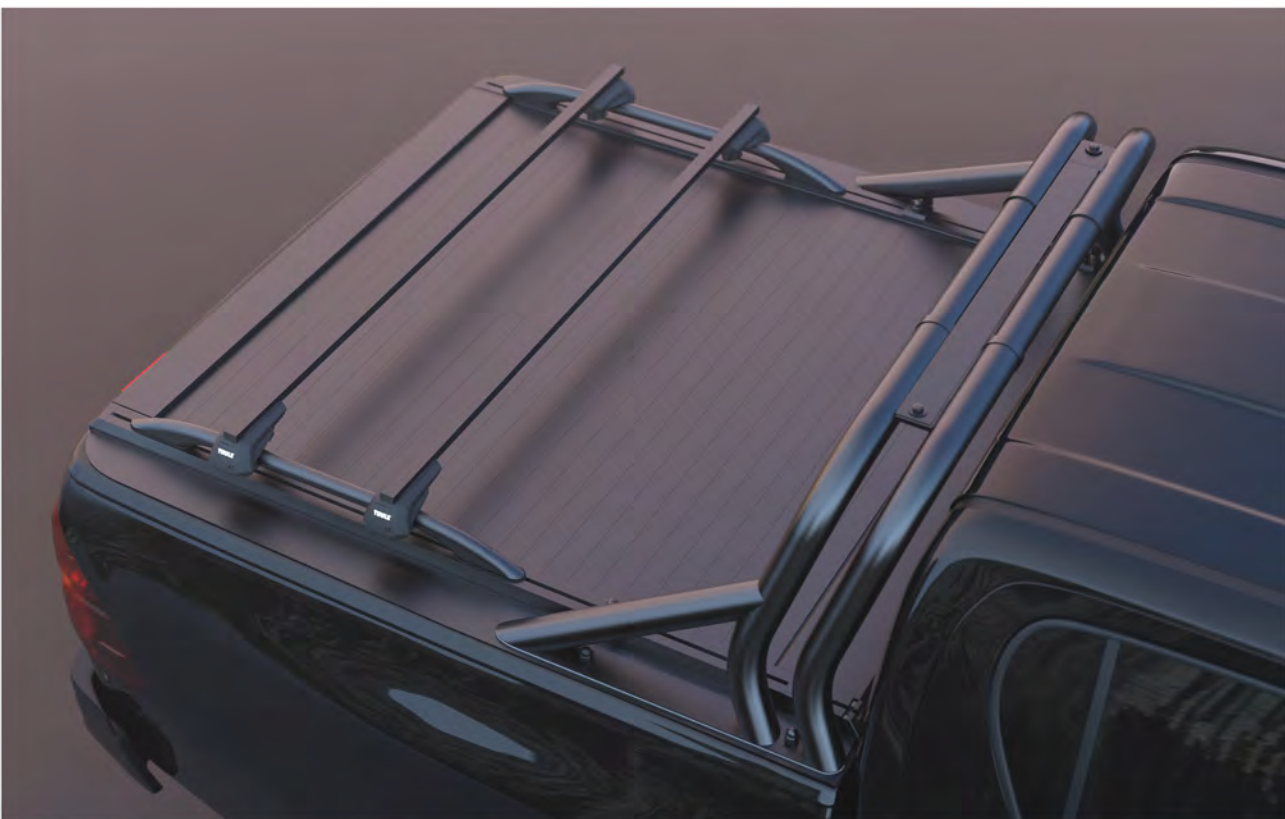

## T-SLOTS

Side rail parts with built in T-SLOTS.  
Easy & secure installation,  
with NO DRILL,  
of extra accessories:  
Roll Bars,  
Side handrails  
and Cross Racks.

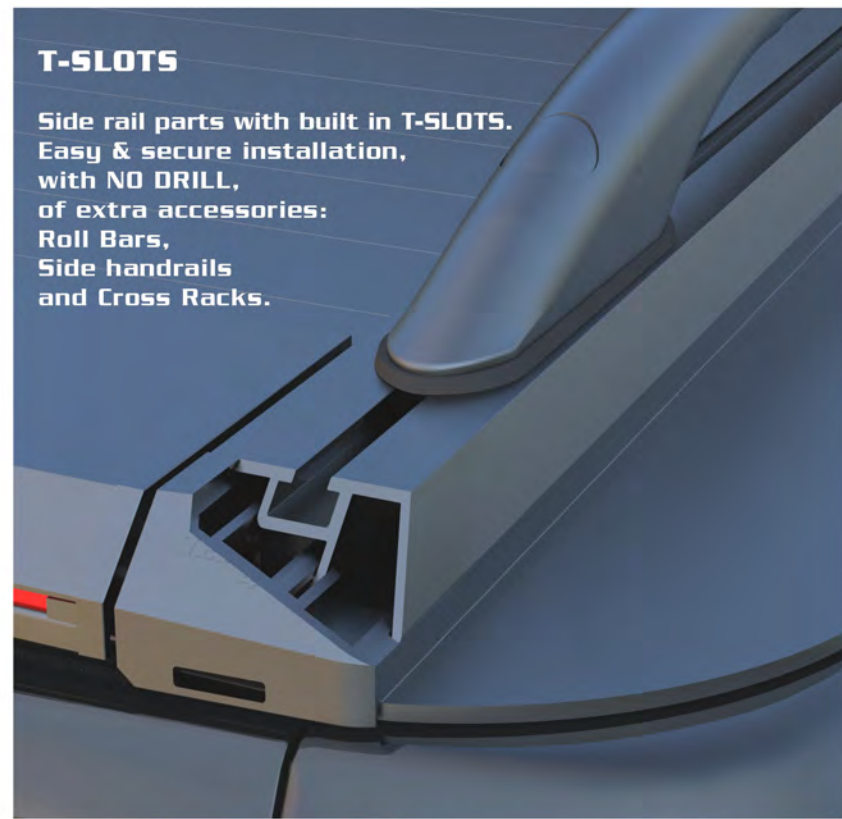





---

**MEET THE WORLD'S MOST  
BEAUTIFUL, HIGH QUALITY  
AND DURABLE  
ROLL TOP COVER**

---







# Triple operation system

## Mobile Phone Application

Simply download “Tessera4x4 App” on your mobile phone (compatible with iOS/Android) to control your roll top cover



## Built into our rear slat

which allows you to open/close the roll unit with an effortless tap.

\*(for security reasons this method works only when you are close to the pickup vehicle with your mobile phone)

## Key fob remote

Specially designed key fob remote for the main functions of the roll top cover

# Tessera4x4





## Obstacle sensors

Tessera Roll+ top cover has the ability to recognise obstacles thanks to the located sensors into the rear slat without interrupting motor power in extreme weather conditions (i.e., snow & ice) In case of emergency it stops and reverses automatically





# It's maths

## BASIC VERSION

Easy & simple open-close manual operation.

### REVOLUTIONARY DESIGN - UPGRADE ANYTIME

Easy upgrade from Basic to Spring or Electric version  
by JUST adding the kit of your preference.

The only roll top cover in the global market that its basic version can be transformed to manual version with spring or electric version, by using just an extra kit. By achieving this, we managed to create huge capability for B2B customers as they can store 3 times more stock and B2C customers can upgrade their basic version easily at any time.



**time: 1=3**

### **SPRING VERSION**

Easy & comfort use.

Upgrade from Basic to Spring version  
by simply adding s-Kit.

Put spring motion to roll top cover  
and work more efficiently.

### **ELECTRIC VERSION**

Easy and automatic use.

Add e-Kit  
and put electric motion  
to the roll top cover.

e-Kit comes with a specially  
designed AI controller board  
with the following benefits:

- No need for calibration
- Soft open/close feature
- Maintenance popup alerts
- Mobile App facilities



**Sealed and Water Proof  
resistant electric motor**

Located & protected inside  
the aluminium (heavy duty)  
central shaft.

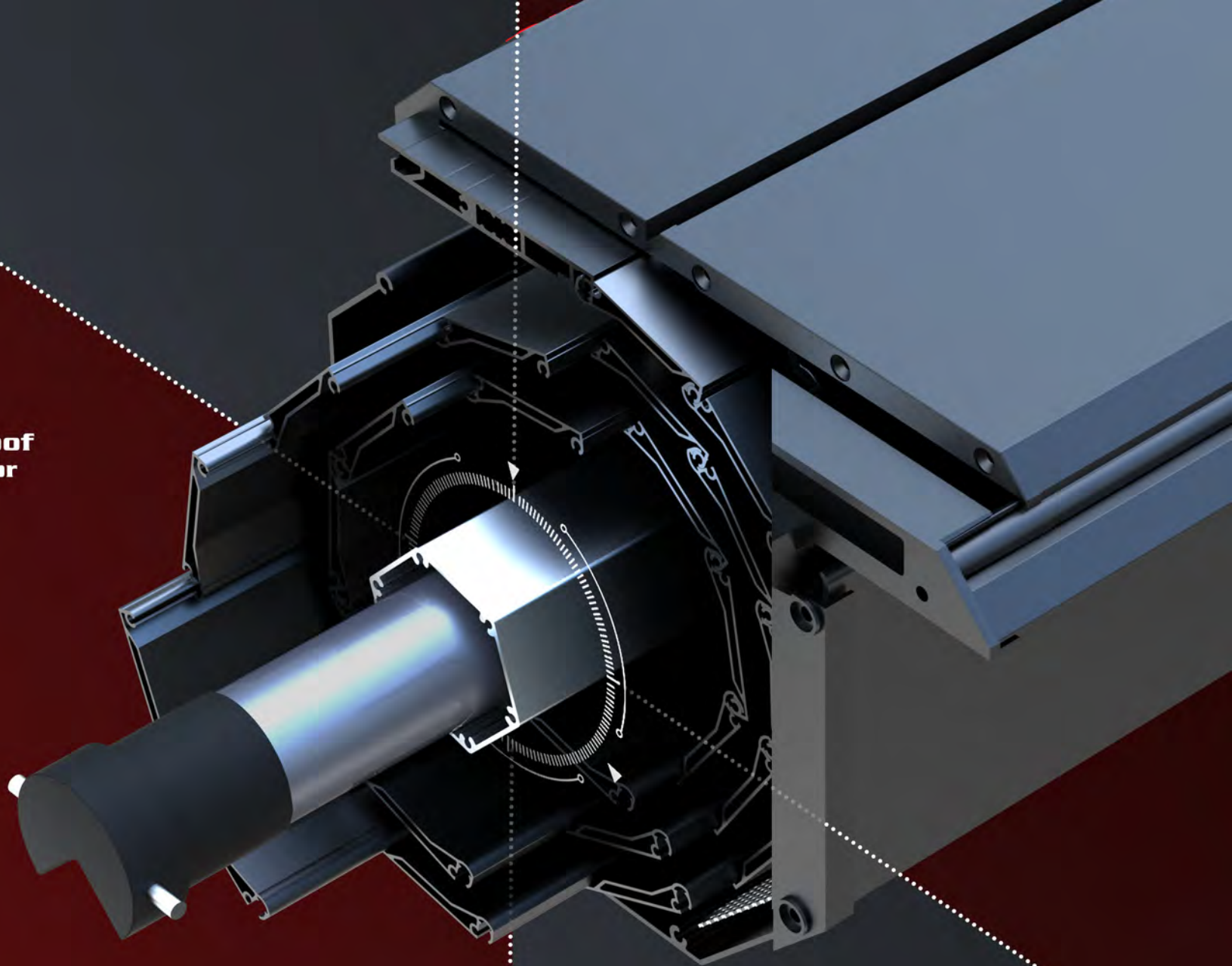



## Red LED light bar

A beautiful and practical red led light bar, that can be used as beam light, brake lamp, and in case of e-Kit as obstacle warning flash alert or even as an emergency alarm.

## White LED interior light bar

A moving full-length white led light bar located inside the rolling slats in order to spot and focus the trunk area better.

Tessera4x4





**Knife proof:**  
Specially designed “Knife proof” slats  
provide 100% security for the load.



**Interior Locking system**  
for preventing unauthorised access



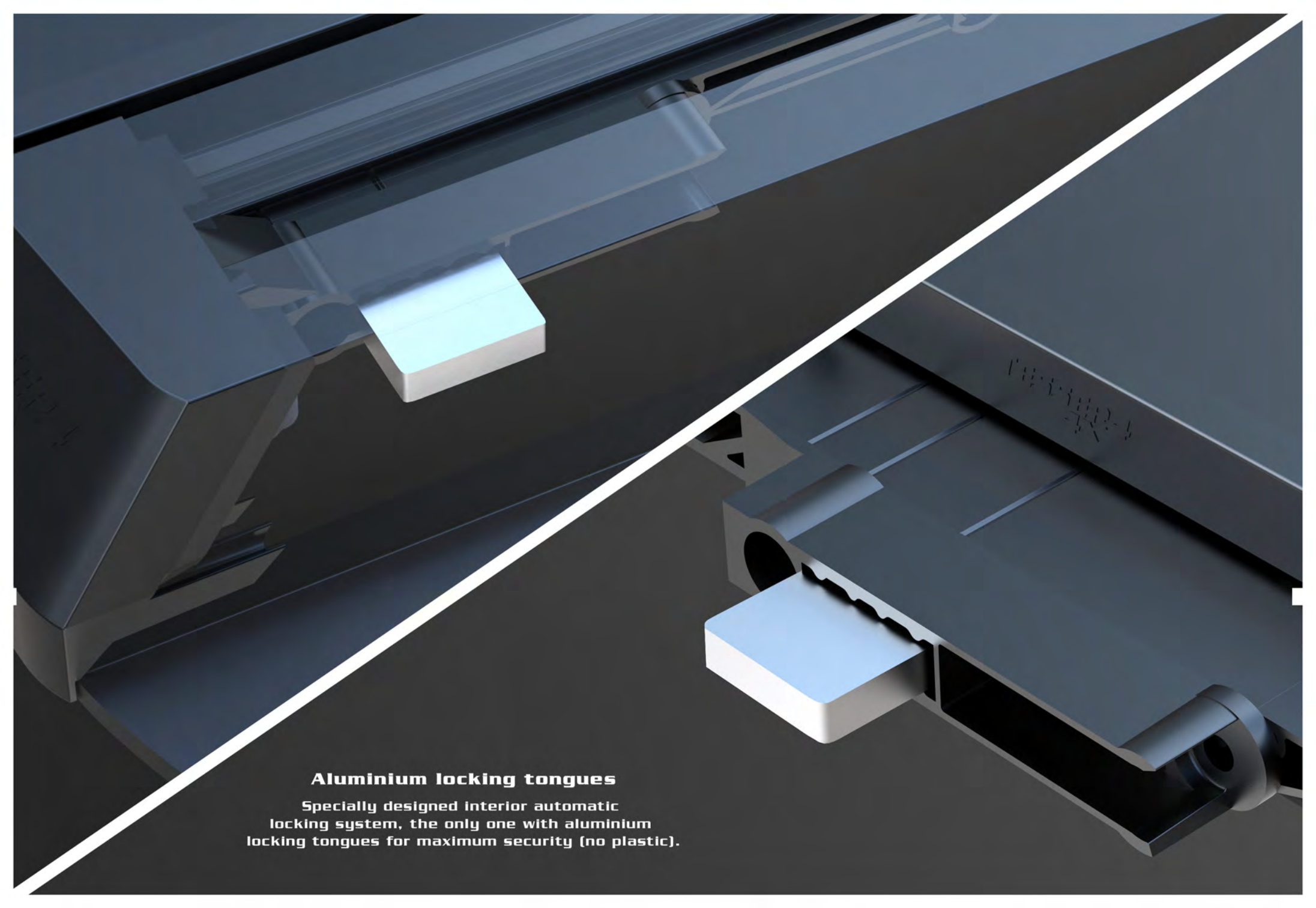

**Aluminium locking tongues**

Specially designed interior automatic locking system, the only one with aluminium locking tongues for maximum security (no plastic).

# The Ultimate weather protection systems

2 Big drains into the side rail parts

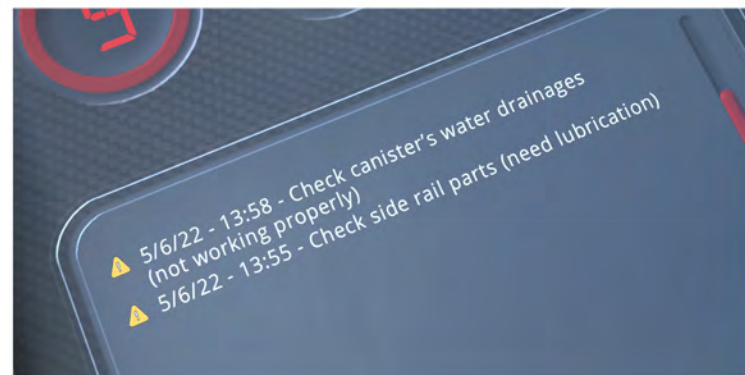
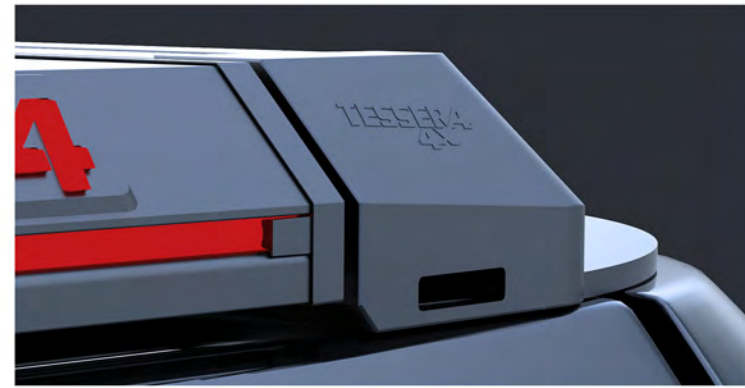



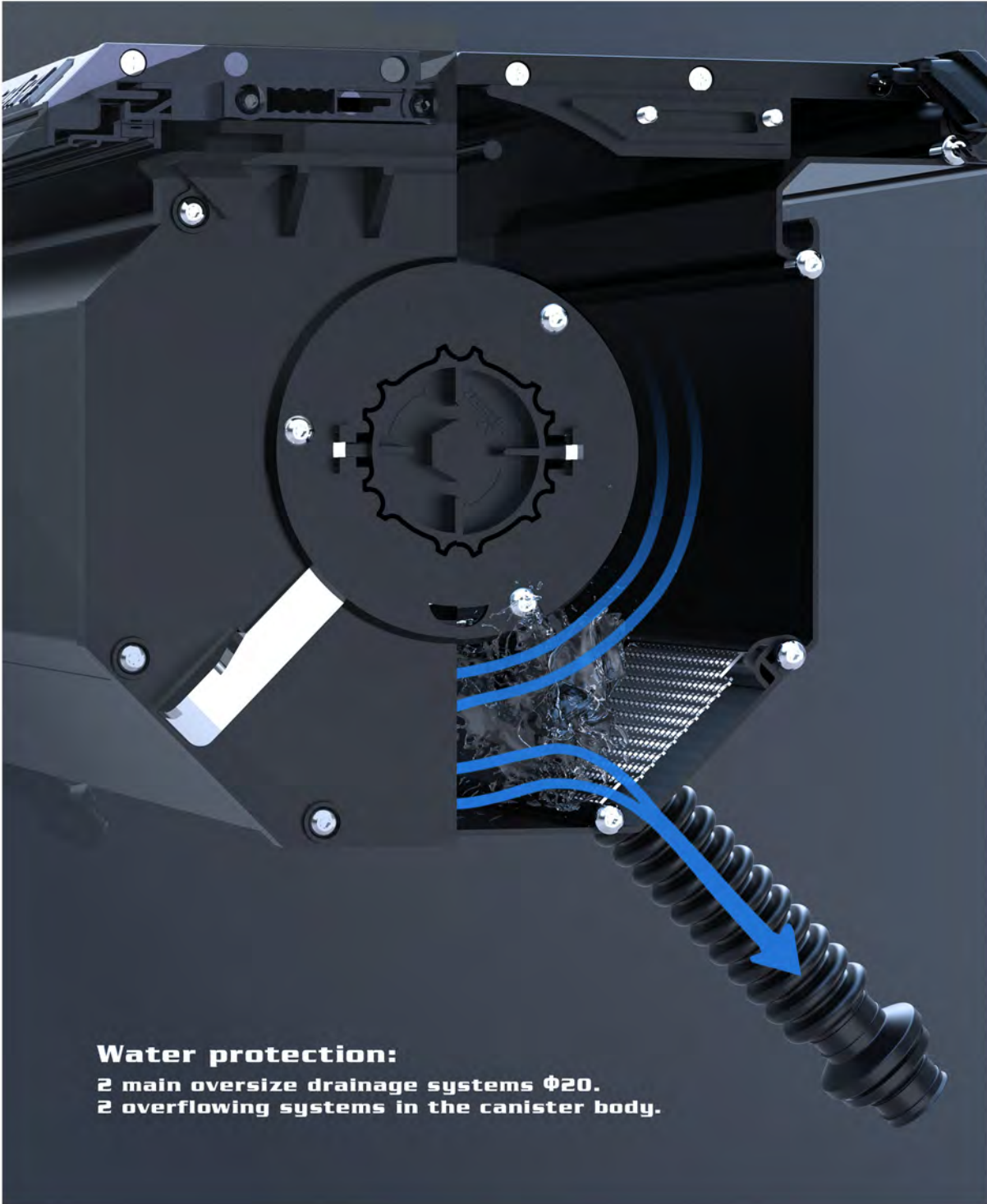

**Water protection:**

2 main oversize drainage systems  $\Phi 20$ .  
2 overflowing systems in the canister body.



**Anti-leaf system:**

The only roll top cover in the global market with a specially made obstruction system (anti-leaf system), to protect the water drains of canister from leaves and small trash



**Makes your life easy**



**Easy access to canister body.**



**Our specially designed rear slat  
now goes inside the canister area.**

An innovative design that offers the advantage  
of maximizing load net capacity  
both in length & height.

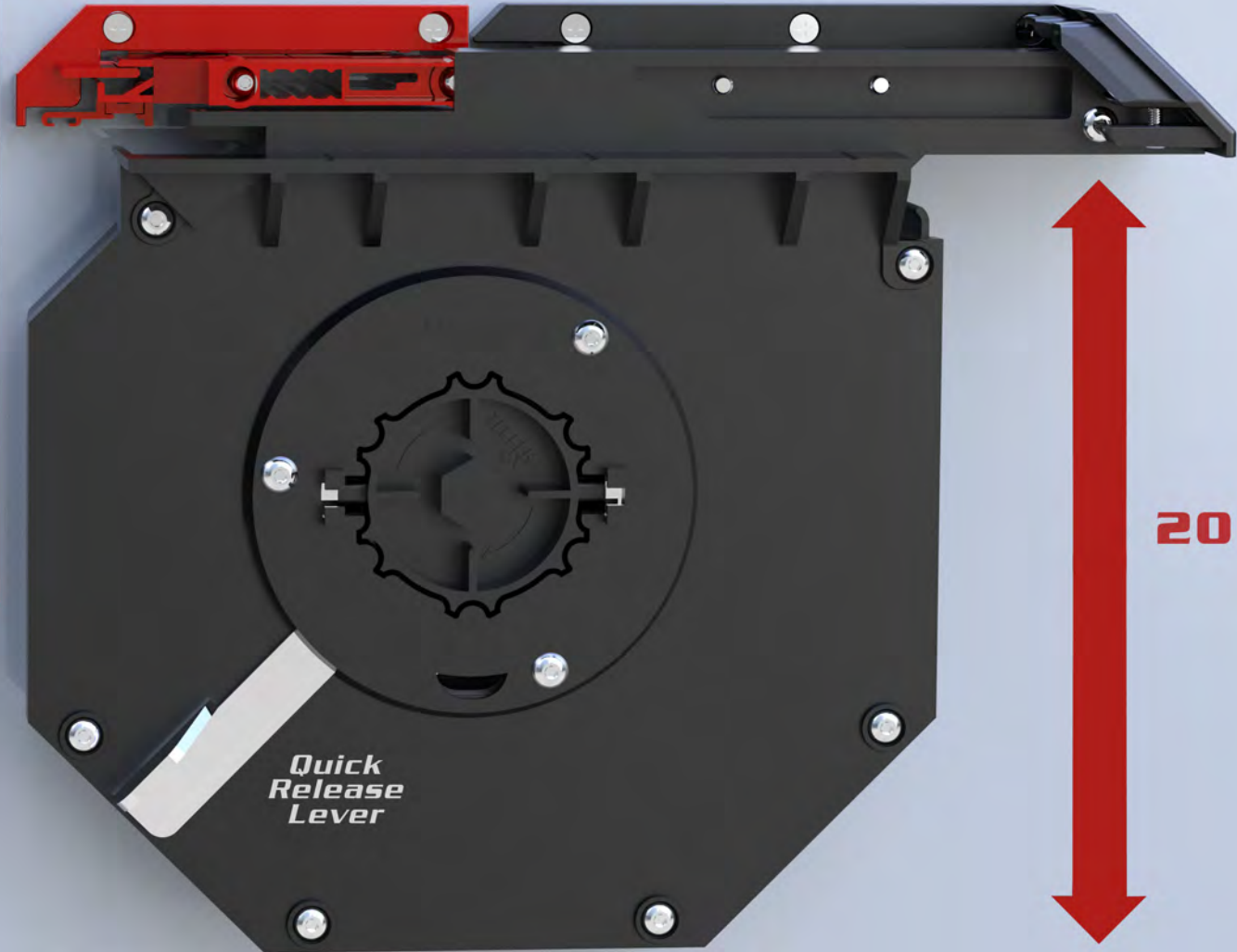

**20 cm**

**23 cm**



**Experience a whole new environment  
of configurations**



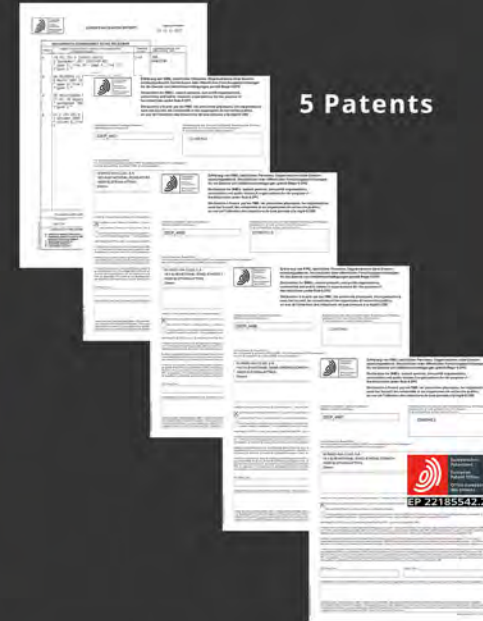

## The Company

Leading the way with precision, pioneering technology and passion in everything we do, Tessera4x4 accessories have successfully been established as one of the largest European 4x4 accessories centers for pickup trucks, and SUV vehicles for over 35 years.

In addition to our undisputed superiority in the Greek market, the products of Tessera4x4 accessories ships to more than 40 countries in five different continents.

As industry leading experts, we have already conquered the world with our premium quality and patented SOT-ROLL series with Tessera4x4 Roll top covers.

We are excited and proud to announce our new chapter and next generation of roll top covers "Tessera Roll+" series. Our innovative design team thrive on identifying the latest technology and trends our customers want and deserve. Never satisfied with our world renown products, we have continuously been looking at ways of redefining the market by creating the products of tomorrow for all your pickup truck and SUV needs.

Our customers have always been our top priority, and we continue to give them the best unrivalled service possible. Each order is dealt by our helpful and friendly sales team and tailored to meet individual customer requirements. With the option of choosing and ordering online or via email, purchasing your favorite 4x4 accessories has never been easier.

## DISCLAIMER

Vehicles and accessories as shown in this brochure are only for illustration purposes and may vary from the accessories as available in your market. The color of any accessory as shown in this brochure is subject to the limitations of the computer-generated imagery technique and may vary from the color of the actual items. No party can derive any rights from this brochure with respect to any availability or presentation of the vehicles and accessories shown. No part of this brochure may be copied, reproduced, distributed, made available, modified, edited, changed, used or served for any purposes without the prior written approval of Tessera4x4 accessories.



**TESSERA**<sup>®</sup>  
OFF ROAD ACCESSORIES  
**4x4**

*Think Quality!*

**Tessera4x4  
accessories**

19.5 km EO Athinon Korinthou  
Elefsina, Greece, Zip Code: 19200  
GPS address: 38.050320, 23.564402

Tel: (+30) 210 5542813 - 5541161 - 5541154

Mobile: (+30) 6947901533

Fax: (+30) 210 5541 443

email: [info@gianso.gr](mailto:info@gianso.gr)

[www.tessera4x4.com](http://www.tessera4x4.com)

ON SOCIAL MEDIA

FOLLOW US

